

# ABS07-120-32.768kHz-T; TUNING FORK CRYSTAL

32.768kHz SMD; ESR OPTIMIZED CRYSTAL



**RoHS**  
Compliant



3.2 x 1.5 x 0.9 mm

**Moisture Sensitivity Level (MSL) – This product is Hermetically Sealed and not Moisture Sensitive - MSL = N/A: Not Applicable**

## FEATURES:

- Guaranteed ESR of 60kΩ Maximum for Low Power Designs
- 0.9mm height ideal for high density circuit boards
- Seam sealed ceramic package offers excellent environmental & heat resistance
- Extended Operating temperature of -40°C to +85°C for industrial applications

## APPLICATIONS:

- Power sensitive designs requiring Low ESR Crystal, such as ST-Micro MCU STM32L based solutions
- Communication & measurement equipment
- Commercial, Consumer & Industrial applications
- Wireless communications
- PDA and Smartphone

## STANDARD SPECIFICATIONS

Parameters	Minimum	Typical	Maximum	Units	Notes
Frequency		32.768		kHz	
Operation Mode	Tuning Fork – AT Cut				
Operating Temperature	-40		+85	°C	
Storage Temperature	-55		+125	°C	
Frequency Tolerance @+25°C	-20		+20	ppm	Tested at 0.1uW
Temperature Coefficient:	-0.045	-0.035	-0.025	ppm/T <sup>2</sup>	
Turn-over temperature:	+20	+25	+30	°C	
Equivalent series resistance (R1)		55	60	kΩ	
Shunt capacitance (C0)		1.20		pF	
Motional capacitance (Cm)	3.0	3.7	4.4	fF	
Load capacitance (CL)		6.0		pF	
Drive Level		0.1	0.5	μW	
Q value	13000				
Aging@25°C±3°C	-3		3	ppm	First year
Insulation Resistance	500			MΩ	@ 100Vdc ± 15V

## PART IDENTIFICATION: ABS07-120-32.768 kHz-T

## FREQUENCY VARIATION OVER OPERATING TEMPERATURE; RELATIVE TO MEASURED FREQUENCY AT 25°C

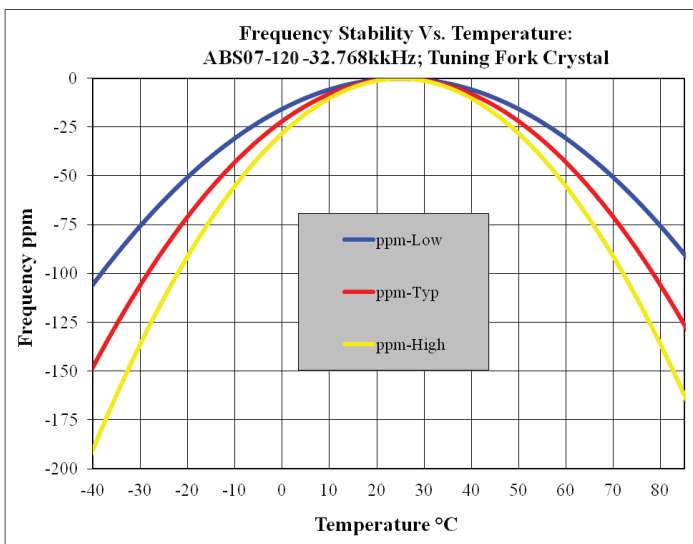

Temp °C	(ppm) Low	(ppm) Typ	(ppm) High
-40	-105.63	-147.88	-190.13
-35	-90.00	-126.00	-162.00
-30	-75.63	-105.88	-136.13
-25	-62.50	-87.50	-112.50
-20	-50.63	-70.88	-91.13
-15	-40.00	-56.00	-72.00
-10	-30.63	-42.88	-55.13
-5	-22.50	-31.50	-40.50
0	-15.63	-21.88	-28.13
5	-10.00	-14.00	-18.00
10	-5.63	-7.88	-10.13
15	-2.50	-3.50	-4.50
20	-0.63	-0.88	-1.13
25	0.00	0.00	0.00
30	-0.63	-0.88	-1.13
35	-2.50	-3.50	-4.50
40	-5.63	-7.88	-10.13
45	-10.00	-14.00	-18.00
50	-15.63	-21.88	-28.13
55	-22.50	-31.50	-40.50
60	-30.63	-42.88	-55.13
65	-40.00	-56.00	-72.00
70	-50.63	-70.88	-91.13
75	-62.50	-87.50	-112.50
80	-75.63	-105.88	-136.13
85	-90.00	-126.00	-162.00

ABRACON IS  
ISO9001:2008  
CERTIFIED



Visit [www.abracon.com](http://www.abracon.com) for Terms & Conditions of Sale **Revised: 10.08.12**  
30332 Esperanza, Rancho Santa Margarita, California 92688  
tel 949-546-8000 | fax 949-546-8001 | [www.abracon.com](http://www.abracon.com)

# ABS07-120-32.768kHz-T; TUNING FORK CRYSTAL

32.768kHz SMD; ESR OPTIMIZED CRYSTAL



RoHS  
Compliant



3.2 x 1.5 x 0.9 mm

## OUTLINE DRAWING:

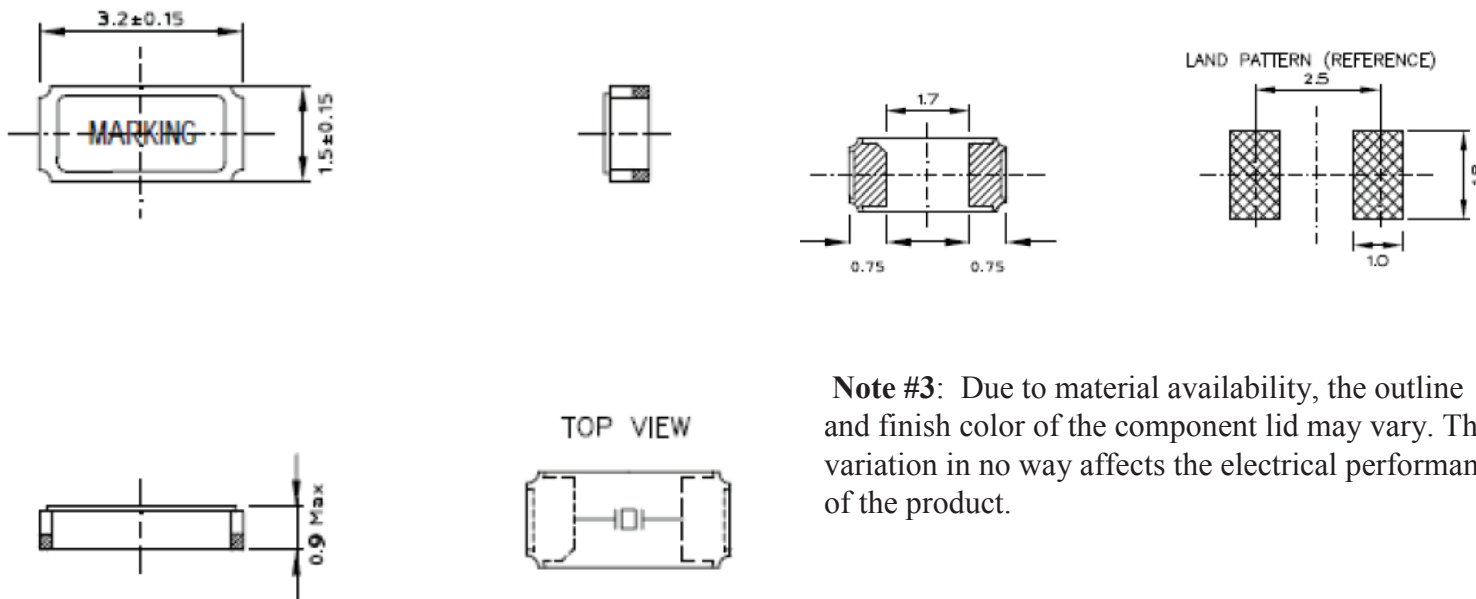

**Note #3:** Due to material availability, the outline and finish color of the component lid may vary. This variation in no way affects the electrical performance of the product.

All dimensions are in mm

## REFLOW PROFILE:

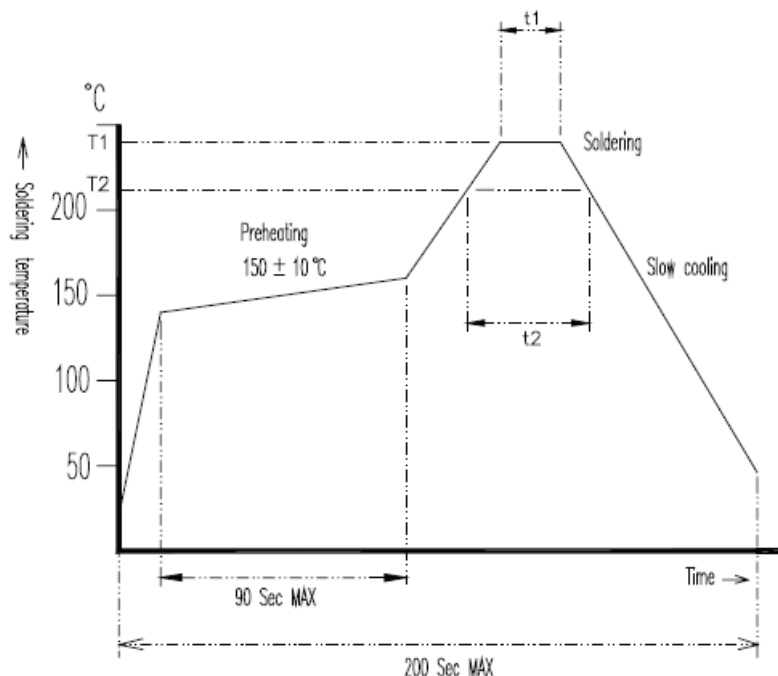

Application \ Temperature	Time	T1 / t1	T2 / t2
Lead Free		260 ± 5°C / 10-seconds Max.	225 Min / 60 Seconds Max.

# ABS07-120-32.768kHz-T; TUNING FORK CRYSTAL

32.768kHz SMD; ESR OPTIMIZED CRYSTAL



RoHS  
Compliant



3.2 x 1.5 x 0.9 mm

## TAPE & REEL:

T=Tape and reel (3,000pcs/reel)

REEL : 3000PCS

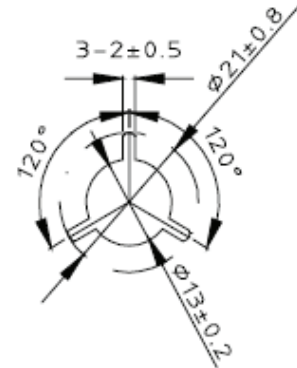
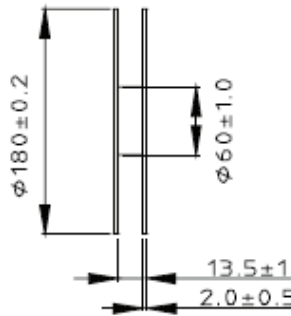
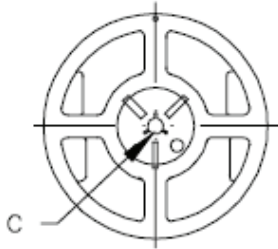

C.ENLARGE

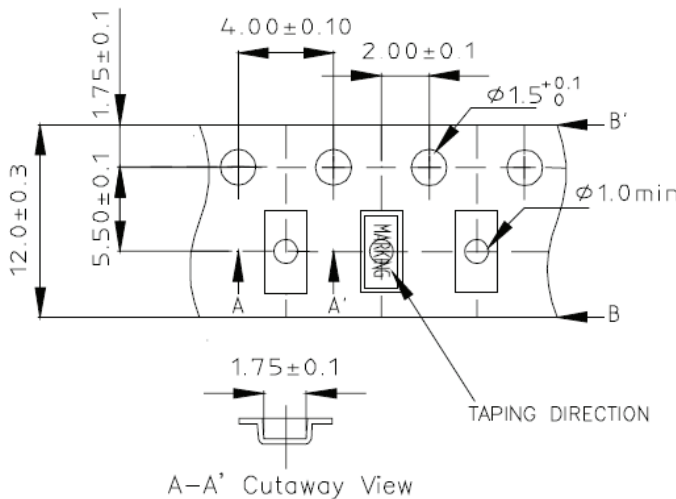

A-A' Cutaway View

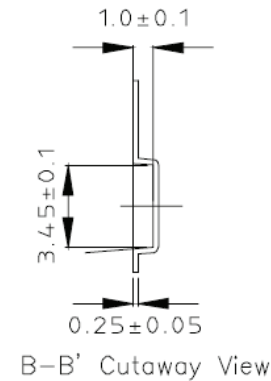

B-B' Cutaway View

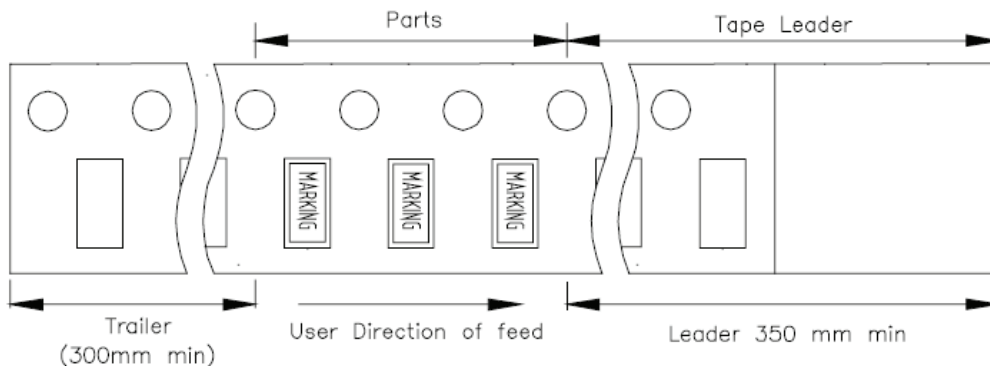

**ATTENTION:** Abracon Corporation's products are COTS – Commercial-Off-The-Shelf products; suitable for Commercial, Industrial and, where designated, Automotive Applications. Abracon's products are not specifically designed for Military, Aviation, Aerospace, Life-dependant Medical applications or any application requiring high reliability where component failure could result in loss of life and/or property. For applications requiring high reliability and/or presenting an extreme operating environment, written consent and authorization from Abracon Corporation is required. Please contact Abracon Corporation for more information.

ABRACON IS  
ISO9001:2008  
CERTIFIED



Visit [www.abracon.com](http://www.abracon.com) for Terms & Conditions of Sale **Revised: 10.08.12**  
30332 Esperanza, Rancho Santa Margarita, California 92688  
tel 949-546-8000 | fax 949-546-8001 | [www.abracon.com](http://www.abracon.com)